

WE ARE
IN BETTER
CONTROL
I'M IN
BETTER
CONTROL

Since 1989 Controltech delivers only the best. We have an all around set for all your needs.

From MTB to Road to Triathlon Controltech products are the perfect choice when you want to push the limits.

Controltech is for people who never live in their comfort zone.

INDEX



NEW PRODUCTS 08

ROAD

COUGAR	18
TIMANIA	20
TUX	22
EXL	26
SLA	28
CLS	30
FALCON	32
ONE	36

MTB

TIMANIA	44
TUX	46
EXL	48
SLA	50
CLS	52
LYNX	54
MST	58
ONE	60

TT

TIME ZONE	68
AERO-IMPEL	69
FALCON	72
BULL HORN	73

NON SERIES ACCESSORIES

76
77

ROAD CHART

RACE SPORT TOURING CYCLOCROSS

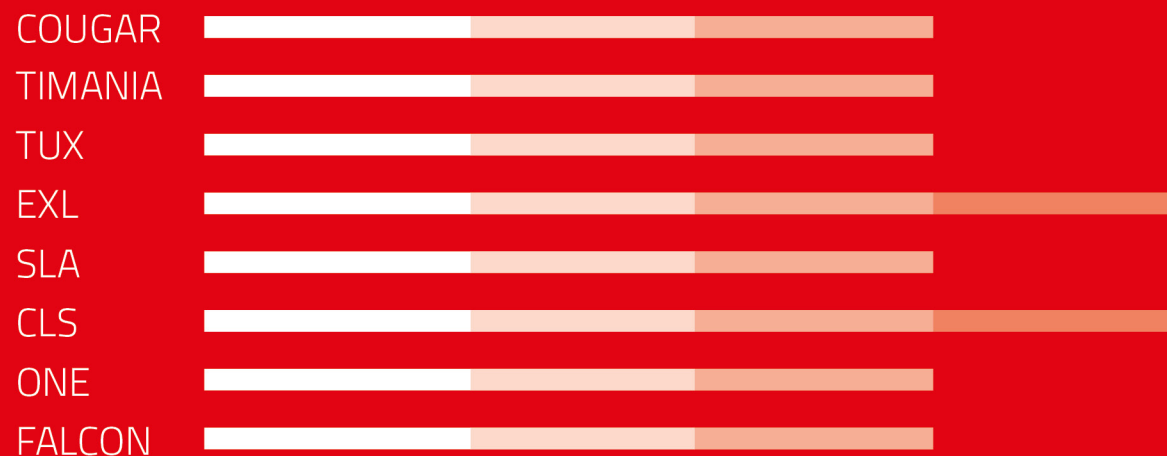

MTB CHART

DH FREE RIDE ALL MOUNTAIN TRAIL XC RACE TREKKING

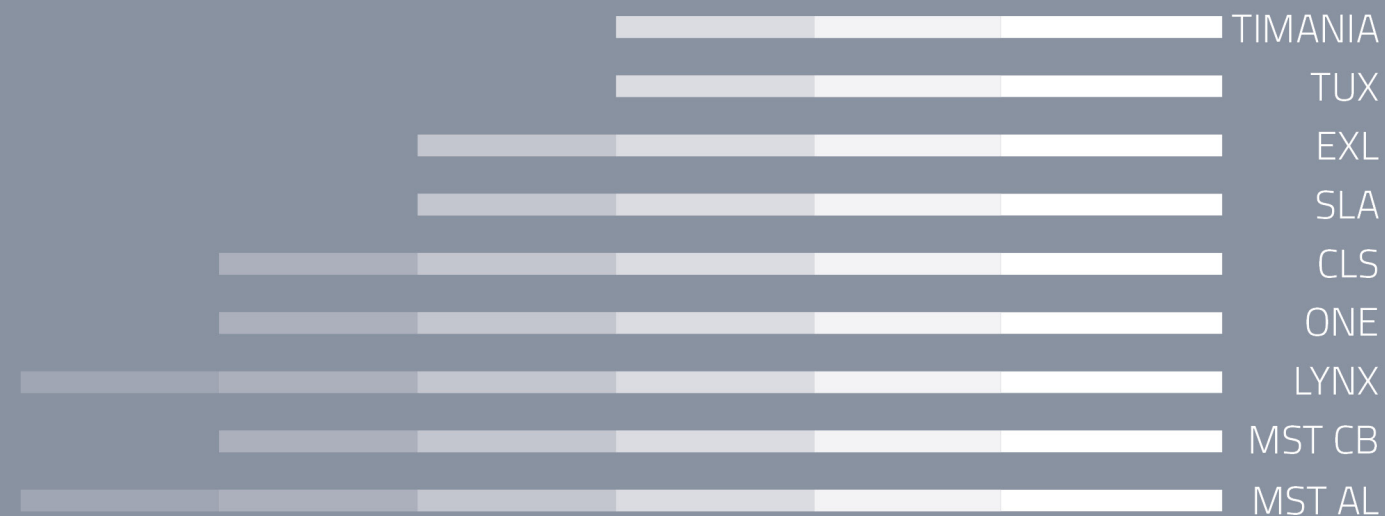

NEW PRODUCTS

COUGAR CARBON HANDLEBAR RA-522

MATERIAL: CARBON FIBER
 BARBOREØ: 31.8MM
 WIDTH: 400/420/440MM
 REACH: 78MM
 DROP: 125MM
 OUTWARD BEND: 4°
 WEIGHT: 237G(420MM)
 COMPATIBLE WITH SHIMANO NEW DI2 JUNCTION BOX
 PCS COMPATIBLE
 AERODYNAMIC



Triangle section for better control



COUGAR ALLOY HANDLEBAR RA-531

MATERIAL: AL6061
 BARBOREØ: 31.8MM
 WIDTH: 400/420/440MM
 REACH: 78MM
 DROP: 125MM
 OUTWARD BEND: 4°
 WEIGHT: 310G(420MM)
 COMPATIBLE WITH SHIMANO NEW DI2 JUNCTION BOX
 PCS COMPATIBLE



Triangle section for better control



TUX COMPACT ROAD BAR RA-523

MATERIAL: UD CARBON
 BARBOREØ: 31.8MM
 WIDTH: 400/420/440MM
 REACH: 75MM
 DROP: 125MM
 OUTWARD BEND: 4°
 WEIGHT: 169G(420MM)
 COLOR: RED/GRAY
 COMPATIBLE WITH SHIMANO NEW DI2 JUNCTION BOX



Triangle section for better control

EXL GRAVEL BAR RA-524

MATERIAL: UD CARBON
 BARBOREØ: 31.8MM
 WIDTH: 400/420/440MM
 REACH: 75MM
 DROP: 145MM
 RISE: 20MM
 BACK SWEEP: 6°
 OUTWARD BEND: 16°
 WEIGHT: 250G(420MM)
 COLOR: RED/GRAY
 COMPATIBLE WITH SHIMANO NEW DI2 JUNCTION BOX



EXL GRAVEL COMPACT RA-534

MATERIAL: UD CARBON
 BARBOREØ: 31.8MM
 WIDTH: 400/420/440MM
 REACH: 75MM
 DROP: 125MM
 RISE: 20MM
 BACK SWEEP: 6°
 OUTWARD BEND: 16°
 WEIGHT: 250G(420MM)
 COLOR: RED/GRAY
 COMPATIBLE WITH SHIMANO NEW DI2 JUNCTION BOX



Triangle section for better control

EXL COMPACT ROAD BAR RA-526

MATERIAL: UD CARBON
 BARBOREØ: 31.8MM
 WIDTH: 400/420/440MM
 REACH: 75MM
 DROP: 125MM
 OUTWARD BEND: 4°
 WEIGHT: 205G(420MM)
 COLOR: RED/GRAY
 COMPATIBLE WITH SHIMANO NEW DI2 JUNCTION BOX



Triangle section for better control

CONTROL LIGHT

**SLA COMPACT ROAD BAR
RA-513**

MATERIAL: AL7050
BARBOREØ: 31.8MM
WIDTH: 400/420/440MM
REACH: 75MM
DROP: 125MM
OUTWARD BEND: 4°
WEIGHT: 250G(420MM)
COLOR: RED/GRAY
COMPATIBLE WITH SHIMANO NEW
DI2 JUNCTION BOX



**CLS COMPACT ROAD BAR
RA-533**

MATERIAL: AL6061
BARBOREØ: 31.8MM
WIDTH: 400/420/440MM
REACH: 75MM
DROP: 125MM
OUTWARD BEND: 4°
WEIGHT: 295G(420MM)
COLOR: RED/GRAY



**CLS GRAVEL RISER
RA-530**

MATERIAL: AL6061
BARBOREØ: 31.8MM
WIDTH: 400/420/440MM
REACH: 75MM
DROP: 125MM
RISE: 20MM
OUTWARD BEND: 16°
WEIGHT: 330G(420MM)
COLOR: RED/GRAY



**CLS ROAD RISER
RA-532**

MATERIAL: AL6061
BARBOREØ: 31.8MM
WIDTH: 400/420/440MM
REACH: 75MM
DROP: 125MM
RISE: 20MM
OUTWARD BEND: 4°
WEIGHT: 330G(420MM)
COLOR: RED/GRAY



**TIMANIA FLAT TOP BAR
ATB-302**

MATERIAL: 3AL-2.5V
BARBOREØ: 31.8MM
WIDTH: 720/760MM
BACK SWEEP: 9°
WEIGHT: 275G(760MM)



**LYNX 31.8 DI2 FLAT TOP BAR
ATB-381DB6-DI2**

MATERIAL: AL6061
BARBOREØ: 31.8MM
LENGTH: 700/760/800MM
BACK SWEEP: 9°
WEIGHT: 307G (760MM/DI2)
COLOR: RED/GRAY
COMPATIBLE WITH SHIMANO MTB DI2 SYSTEM



**LYNX 31.8 RISER BAR
ATB-384DB6-DI2**

MATERIAL: AL6061
BARBOREØ: 31.8MM
LENGTH: 710/750/800MM
BACK SWEEP: 9°
UP SWEEP: 4°
RISE: 15MM
WEIGHT: 316G (750MM/DI2)
COLOR: RED/GRAY
COMPATIBLE WITH SHIMANO MTB DI2 SYSTEM



COUGAR CARBON HEX SEATPOST SP-1570

MATERIAL: UD CARBON
POSTØ: 27.2/31.6MM
LENGTH: 350MM
OFFSET: 20/10/-5/-10MM
WEIGHT: 253G(TBD)
(L350MM, Ø27.2MM)



FALCON ALLOY HEX SEATPOST SP-1540

MATERIAL: AL6061
POSTØ: 27.2/31.6MM
LENGTH: 350MM
OFFSET: 20/10/-5/-10MM
WEIGHT: 353G(TBD)
COLOR: RED/GRAY



EXL LIGHT CARBON SEATPOST SP-1520

MATERIAL: UD CARBON
POSTØ: 27.2/31.6MM
LENGTH: 350/400MM
OFFSET: 12MM
WEIGHT: 180G
(L350MM, Ø27.2MM)
COLOR: RED/GRAY



SLA LIGHT ALLOY SEATPOST SP-1560

MATERIAL: AL7050
POSTØ: 27.2/31.6MM
LENGTH: 350MM
OFFSET: 12MM
WEIGHT: 195G
(L350MM, Ø27.2MM)
COLOR: RED/GRAY



COUGAR STEM RAS-92

MATERIAL: AL6061
HANDLEBARØ: 31.8MM
STEERERØ: 28.6MM
LENGTH: 90/100/110/120MM
ANGLE: -5°
WEIGHT: 182G(110MM)
PCS COMPATIBLE



COUGAR AERO ALLOY STEM RAS-94

MATERIAL: AL6061
HANDLEBARØ: 31.8MM
STEERERØ: 28.6MM
LENGTH: 80/90/100/110MM
ANGLE: -6°
WEIGHT: 220G (100MM)(TBD)
INTEGRATED STEM CAP
HIDDEN FACEPLATE BOLTS



LYNX DI2 STEM RAS-96DI2

MATERIAL: AL6061
HANDLEBARØ: 31.8MM
STEERERØ: 28.6MM
LENGTH: 60/70MM
ANGLE: -5°
WEIGHT: 123G(60MM)(TBD)
IDEAL FOR ALL MOUNTAIN & ENDURO 27.5 AND 29ER
COLOR: RED/GRAY
COMPATIBLE WITH SHIMANO MTB DI2 SYSTEM



COUGAR HEADSET HS-957

MATERIAL: AL6061
Size: UPPER 1-1/8"
BOTTOM 1-1/2"
DiameterØ: 48MM
WEIGHT: 108G



CARBON BOTTLE CAGE BC-37

MATERIAL: UD CARBON
WEIGHT: 22G
COLOR: RED/GRAY



COUGAR FORK F-175I / 176I

MATERIAL: CARBON FIBER
STEERER: UP 1-1/8"
DOWN: 1-1/2"
CROWN: 57MM
CROWN RACE: 39.8MM
OFFSET: 43MM
WEIGHT: 475G
FLAT MOUNT
PCS COMPATIBLE



**TIME ZONE AEROBAR
TTH-17**

MATERIAL: UD CARBON
 WIDTH: 400MM
 LENGTH: MAX. 300MM(C TO TOP) , MIN. 240MM
 EXTENSION BAR: S BAR, UP / DOWN ANGLE: 20°
 EXTENSION BAR: S BAR, R / L ANGLE: 10°
 ARMRESTS R / L ADJUSTABLE : R/30MM, L/30MM
 ARMRESTS F / B ADJUSTABLE : F/50MM, B/50MM
 ARMREST'S +/- ADJUSTABLE ANGLE: 10°(+/-5°)
 OPTION SPACERS: 20MM OR 40MM OR 60MM
 WEIGHT: 650G(TBD)
 COLOR: RED/GRAY

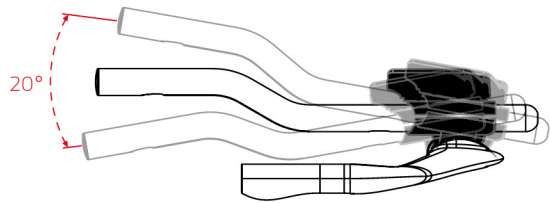
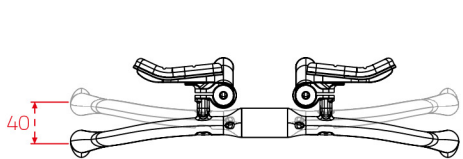
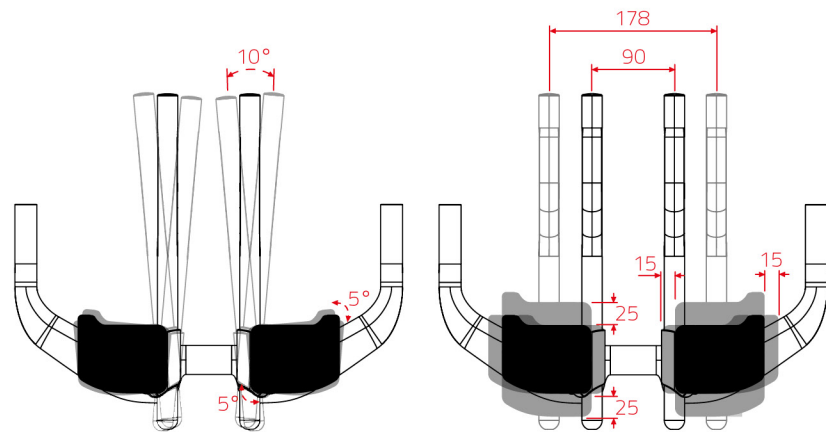

SMART BAR GRIP

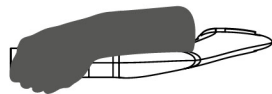

TT - COMBAT MODE

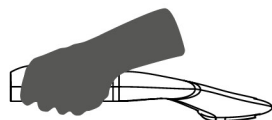

TRIATHLON - ENDURANCE MODE



**FALCON SPEED SADDLE
SD-22**

MATERIAL: POLYPROPYLENE+ALLOY
 LENGTH: 275MM
 WIDTH: 145MM
 WEIGHT: 285G
 COLOR: GRAY

**LYNX SADDLE
SD-23**

MATERIAL: POLYPROPYLENE+ALLOY
 LENGTH: 275MM
 WIDTH: 145MM
 WEIGHT: 285G
 COLOR: GRAY



**TRI-POWER UNIT
BAG-01**

MATERIAL: TPR+ABS
 CAPACITY: 260CM³
 SIZE: 220x42MM
 WEIGHT: 155G(TBD)



**THS-01
TIME ZONE HYDRATION
SYSTEM**

MATERIAL: HDPE+PA66-GF30
 CAPACITY: 800ML(TBD)
 SIZE: L 262x W 71x H 191MM
 WEIGHT: 396G(TBD)



ROAD ELEMENTS

OUR components are made with the best material and technology, for guarantee a perfect experience when you ride bicycle.

COMPARISON

CONTROLTECH	SHIMANO	SRAM	FSA	RITCHEY	3T
TUX	DURAACE	RED	K-FORCE LIGHT	SUPERLOGIC	AEROTUNDO / ERGOSUM
EXL	ULTEGRA	FORCE	SL-K LIGHT	WCS CARBON	AERONOVA / ROTUNDO / TORNOVA
COUGAR	ULTEGRA	FORCE	SL-K LIGHT	WCS CARBON	AERONOVA / ROTUNDO / TORNOVA
SLA	105	RIVAL	ENERGY	WCS	ERGOTERRA
CLS	TIAGRA	APEX	GOSSAMER	COMP	
ONE	SORA		OMEGA		

COUGAR



NEW
**COUGAR ALLOY HANDLEBAR
RA-531**

MATERIAL: AL6061
BARBOREØ: 31.8MM
WIDTH: 400/420/440MM
REACH: 78MM
DROP: 125MM
OUTWARD BEND: 4°
WEIGHT: 310G(420MM)
COMPATIBLE WITH SHIMANO NEW DI2
JUNCTION BOX
PCS COMPATIBLE



Triangle section for better control



NEW
**COUGAR AERO ALLOY STEM
RAS-94**

MATERIAL: AL6061
HANDLEBARØ: 31.8MM
STEERERØ: 28.6MM
LENGTH: 80/90/100/110MM
ANGLE: -6°
WEIGHT: 220G (100MM)(TBD)
INTEGRATED STEM CAP
HIDDEN FACEPLATE BOLTS



NEW
**COUGAR STEM
RAS-92**

MATERIAL: AL6061
HANDLEBARØ: 31.8MM
STEERERØ: 28.6MM
LENGTH: 90/100/110/120MM
ANGLE: -5°
WEIGHT: 182G(110MM)
PCS COMPATIBLE



NEW
**COUGAR HEADSET
HS-957**

MATERIAL: AL6061
Size: UPPER 1-1/8"
BOTTOM 1-1/2"
DiameterØ: 48MM
WEIGHT: 108G



NEW
**COUGAR CARBON HANDLEBAR
RA-522**

MATERIAL: CARBON FIBER
BARBOREØ: 31.8MM
WIDTH: 400/420/440MM
REACH: 78MM
DROP: 125MM
OUTWARD BEND: 4°
WEIGHT: 237G(420MM)
COMPATIBLE WITH SHIMANO NEW DI2
JUNCTION BOX
PCS COMPATIBLE
AERODYNAMIC



Triangle section for better control



NEW
**COUGAR CARBON HEX
SEATPOST
SP-1570**

MATERIAL: UD CARBON
POSTØ: 27.2/31.6MM
LENGTH: 350MM
OFFSET: 20/10/-5/-10MM
WEIGHT: 253G(TBD)
(L350MM, Ø27.2MM)



NEW
**COUGAR FORK
F-1751 / 1761**

MATERIAL: CARBON FIBER
STEERER: UP 1-1/8"
DOWN: 1-1/2"
CROWN: 57MM
CROWN RACE: 39.8MM
OFFSET: 43MM
WEIGHT: 475G
FLAT MOUNT
PCS COMPATIBLE

TIMANIA



**TIMANIA ROAD BAR
RA509-8**

MATERIAL: Ti+UD CARBON
BARBOREØ: 31.8MM
WIDTH: 400/420/440MM
REACH: 75MM
DROP: 130MM
WEIGHT: 240G (420MM)



**TIMANIA STEM
ATB-937**

MATERIAL: 6AL-4V TITANIUM
HANDLEBARØ: 31.8MM
STEERERØ: 28.6MM
LENGTH: 70/90/100/110/120MM
ANGLE: +/-5°
WEIGHT: 135G (100MM)

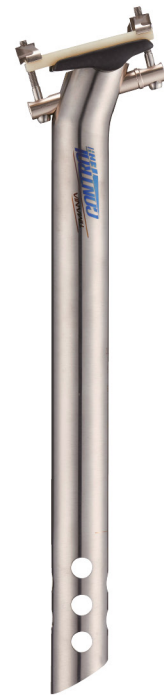

**TIMANIA 12mm OFFSET
SEATPOST
SP-1330**

MATERIAL: 3AL-2.5V TITANIUM
POSTØ: 27.2/31.6MM
LENGTH: 350MM
OFFSET: 12MM
WEIGHT: 199G (L350MM, Ø31.6MM)



**TIMANIA BOTTLE CAGE
BC-30**

MATERIAL: 3AL-2.5V TITANIUM
WEIGHT: 46G(TBD)



**TIMANIA SEAT CLAMP
SC-102**

MATERIAL: 6AL-4V TITANIUM
ID: 31.8MM/34.9MM
WEIGHT: 20G (34.9MM)



**TIMANIA STEM CAP
CAP-44**

MATERIAL: TITANIUM
STEERER: 23.3-25.4MM
BOLT: ALUMINIUM
WEIGHT: 34G



**TIMANIA SPACERS
HSS-12**

MATERIAL: TITANIUM
HEIGHT: 5/10/15MM
WEIGHT: 2.3/4.3/7.3GRAMS

TUX

TUX ROAD BAR RA-476-8UD

MATERIAL: UD CARBON
BARBORE: Ø31.8MM
WIDTH: 400/420/440MM
REACH: 78MM
DROP: 140MM
WEIGHT: 186G (420MM)
COLOR: RED/GRAY



TUX STEM RAS-79-FUD

MATERIAL: UD CARBON+AL7075
HANDLEBARØ: 31.8MM
STEERERØ: 28.6MM
LENGTH: 70/80/90/100/110/120/130MM
ANGLE: +/- 5°
WEIGHT: 115G (90MM)
COLOR: RED/GRAY



TUX OFFSET SEATPOST SP-1340

MATERIAL: UD CARBON
POSTØ: 27.2/31.6MM
LENGTH: 350MM
OFFSET: 24MM
WEIGHT: 184G
(L350MM, Ø27.2MM)
COLOR: RED/GRAY



TUX 10MM OFFSET SEATPOST SP-1440

MATERIAL: UD CARBON
POSTØ: 27.2/31.6MM
LENGTH: 350MM
OFFSET: 10MM
WEIGHT: 195G(L350MM, Ø31.6MM)
COLOR: RED/GRAY



TUX ROAD FORK F-149I

MATERIAL: UD CARBON
BIKE TYPE: 700C
STEERER: UP 1-1/8" DOWN 1-1/2"
CROWN: 56MM
CROWN RACE: 39.8MM
OFFSET: 45MM
WEIGHT: 400G
COLOR: RED/GRAY



NEW

TUX COMPACT ROAD BAR RA-523

MATERIAL: UD CARBON
BARBOREØ: 31.8MM
WIDTH: 400/420/440MM
REACH: 75MM
DROP: 125MM
OUTWARD BEND: 4°
WEIGHT: 169G(420MM)
COLOR: RED/GRAY
COMPATIBLE WITH SHIMANO NEW D12
JUNCTION BOX



Triangle section for better control

WHEELS TUX

TUX R45 TU RIM-63

RIM TYPE: 700C TUBULAR, UD CARBON
RIM DEPTH: 45MM RIM WIDTH: 25MM
AXLE WIDTH (O.L.D.): F: 100MM/R: 130MM
SPOKE: F: 20H/R:24H W/ SAPIM CX RAY AERO
BLACK SPOKES
WEIGHT: 1350G/PAIR
COLOR: RED/GRAY

SHIMANO 11S OR CAMPY COMPATIBLE

TUX R45 TU DISC RIM-63disc

RIM TYPE: 700C TUBULAR, UD CARBON
RIM DEPTH: 45MM RIM WIDTH: 25MM
AXLE WIDTH (O.L.D.): F: 100MM/R: 135MM
SPOKE F: 24H/R: 24H W/SAPIM CX RAY AERO
BLACK SPOKES
WEIGHT: 1480G/PAIR
COLOR: RED/GRAY

SHIMANO 11S OR CAMPY COMPATIBLE

TUX R45 CL RIM-64

RIM TYPE: 700C CLINCHER, UD CARBON
RIM DEPTH: 45MM RIM WIDTH: 23.5MM
AXLE WIDTH (O.L.D.): F: 100MM/R: 130MM
SPOKE: F:20H/R:24H W/SAPIM CX RAY AERO
BLACK SPOKES
WEIGHT: 1520G/PAIR
COLOR: RED/GRAY

SHIMANO 11S OR CAMPY COMPATIBLE

TUX R45 CL DISC RIM-64disc

RIM TYPE: 700C CLINCHER, UD CARBON
RIM DEPTH: 45MM RIM WIDTH: 23.5MM
AXLE WIDTH (O.L.D.): F: 100MM/R: 135MM
SPOKE: F: 24H/R: 24H W/SAPIM CX RAY AERO
BLACK SPOKES
WEIGHT: 1650G/PAIR
COLOR: RED/GRAY

SHIMANO 11S OR CAMPY COMPATIBLE



EXL

NEW

EXL GRAVEL BAR RA-524

MATERIAL: UD CARBON
BARBOREØ: 31.8MM
WIDTH: 400/420/440MM
REACH: 75MM
DROP: 145MM
RISE: 20MM
BACK SWEEP: 6°
OUTWARD BEND: 16°
WEIGHT: 250G(420MM)
COLOR: RED/GRAY
COMPATIBLE WITH SHIMANO
NEW DI2 JUNCTION BOX

NEW

EXL GRAVEL COMPACT RA-534

MATERIAL: UD CARBON
BARBOREØ: 31.8MM
WIDTH: 400/420/440MM
REACH: 75MM
DROP: 125MM
RISE: 20MM
BACK SWEEP: 6°
OUTWARD BEND: 16°
WEIGHT: 250G(420MM)
COLOR: RED/GRAY
COMPATIBLE WITH SHIMANO
NEW DI2 JUNCTION BOX



EXL ROAD BAR RA-510-8UD

MATERIAL: UD CARBON
BARBOREØ: 31.8MM
WIDTH: 380/400/420/440MM
REACH: 70MM
DROP: 124MM (W380-400MM)
126MM (W420-440MM)
WEIGHT: 220G (W420MM)
COLOR: RED/GRAY



Triangle section for better control



EXL STEM RAS-82-FUD

MATERIAL: AL6061+UD CARBON
HANDLEBARØ: 31.8MM
STEERERØ: 28.6MM
LENGTH: 60/70/80/90/100/110/120/130MM
ANGLE: +/- 5°
WEIGHT: 133G (90MM)
COLOR: RED/GRAY

NEW

EXL COMPACT ROAD BAR RA-526

MATERIAL: UD CARBON
BARBOREØ: 31.8MM
WIDTH: 400/420/440MM
REACH: 75MM
DROP: 125MM
OUTWARD BEND: 4°
WEIGHT: 205G(420MM)
COLOR: RED/GRAY
COMPATIBLE WITH SHIMANO NEW
DI2 JUNCTION BOX



NEW

EXL LIGHT CARBON SEATPOST SP-1520

MATERIAL: UD CARBON
POSTØ: 27.2/31.6MM
LENGTH: 350/400MM
OFFSET: 12MM
WEIGHT: 180G
(L350MM, Ø27.2MM)
COLOR: RED/GRAY



EXL 10MM OFFSET SEATPOST SP-1280UD

MATERIAL: UD CARBON
POSTØ: 27.2/30.9/31.6MM
LENGTH: 350/400MM
OFFSET: 10MM
WEIGHT: 253.5G
(L350MM, Ø31.6MM)
COLOR: RED/GRAY



EXL 23MM OFFSET SEATPOST SP-1500UD

MATERIAL: UD CARBON
POSTØ: 27.2/31.6MM
LENGTH: 350MM
OFFSET: 23MM
WEIGHT: 244G
(L350MM, Ø27.2MM)
COLOR: RED/GRAY

Triangle section for better control

SLA



SLA ROAD ERGO BAR RA-519DB7-8

MATERIAL: AL7050
BARBOREØ: 31.8MM
WIDTH: 380/400/420/440MM
REACH: 70MM
DROP: 125MM
WEIGHT: 270G (W400MM)
COLOR: RED/GRAY



SLA STEM RAS-85

MATERIAL: AL7075
HANDLEBARØ: 31.8MM
STEERERØ: 28.6MM
LENGTH: 70/80/90/100/110/120/130MM
ANGLE: +/- 5°
WEIGHT: 107(90MM)
COLOR: RED/GRAY



NEW SLA LIGHT ALLOY SEATPOST SP-1560

MATERIAL: AL7050
POSTØ: 27.2/31.6MM
LENGTH: 350MM
OFFSET: 12MM
WEIGHT: 195G
(L350MM, Ø27.2MM)
COLOR: RED/GRAY



SLA 23mm OFFSET SEATPOST SP-1480

MATERIAL: AL2014
POSTØ: 27.2/31.6MM
LENGTH: 350MM
OFFSET: 23MM
WEIGHT: 242G
(L350MM, Ø27.2MM)
COLOR: RED/GRAY



SLA 10mm OFFSET SEATPOST SP-988

MATERIAL: AL7075
POSTØ: 27.2/30.9/31.6MM
LENGTH: 350/400MM
OFFSET: 10MM
WEIGHT: 242G
(L350MM, Ø27.2MM)
COLOR: RED/GRAY



NEW SLA COMPACT ROAD BAR RA-513

MATERIAL: AL7050
BARBOREØ: 31.8MM
WIDTH: 400/420/440MM
REACH: 75MM
DROP: 125MM
OUTWARD BEND: 4°
WEIGHT: 250G(420MM)
COLOR: RED/GRAY
COMPATIBLE WITH SHIMANO NEW
DIZ JUNCTION BOX



CLS

NEW

CLS COMPACT ROAD BAR RA-533

MATERIAL: AL6061
BARBOREØ: 31.8MM
WIDTH: 400/420/440MM
REACH: 75MM
DROP: 125MM
OUTWARD BEND: 4°
WEIGHT: 290G(420MM)
COLOR: RED/GRAY



NEW

CLS GRAVEL RISER RA-530

MATERIAL: AL6061
BARBOREØ: 31.8MM
WIDTH: 400/420/440MM
REACH: 75MM
DROP: 125MM
RISE: 20MM
OUTWARD BEND: 16°
WEIGHT: 330G(420MM)
COLOR: RED/GRAY



Triangle section for better control

NEW

CLS ROAD RISER RA-532

MATERIAL: AL6061
BARBOREØ: 31.8MM
WIDTH: 400/420/440MM
REACH: 75MM
DROP: 125MM
RISE: 20MM
OUTWARD BEND: 4°
WEIGHT: 330G(420MM)
COLOR: RED/GRAY



Triangle section for better control

Triangle section for better control

CLS GRAVEL BAR RA-518DB6-8

MATERIAL: AL6061
BARBOREØ: 31.8MM
WIDTH: 400/420/440/460MM
OUTWARD BEND: 12°
REACH: 75MM
DROP: 130MM
WEIGHT: 305G (440MM)
COLOR: RED/GRAY



CLS ROAD BAR RA-510DB6-8

MATERIAL: AL6061
BARBOREØ: 31.8MM
WIDTH: 380/400/420/440MM
REACH: 70MM
DROP: 124MM (W380-400MM)
126MM (W420-440MM)
WEIGHT: 290G (420MM)
COLOR: RED/GRAY



CLS DROP STEM RAS-117

MATERIAL: AL6061
HANDLEBARØ: 31.8MM
STEERERØ: 28.6MM
LENGTH: 70/80/90/100/110/120MM
ANGLE: +/- 17°
WEIGHT: 109G (70MM)
COLOR: RED/GRAY



CLS STEM RAS-110

MATERIAL: AL6061
HANDLEBARØ: 31.8MM
STEERERØ: 28.6MM
LENGTH: 60/70/80/90/100/110/120MM
ANGLE: +/- 5°
WEIGHT: 113G(100MM)
COLOR: RED/GRAY



CLS 10mm OFFSET SEATPOST SP-1180

MATERIAL: AL6061
POSTØ: 27.2/31.6MM
LENGTH: 350MM
OFFSET: 10MM
WEIGHT: 285G (L350MM, Ø27.2MM)
COLOR: RED/GRAY



CLS 23mm OFFSET SEATPOST SP-1480

MATERIAL: AL6061
POSTØ: 27.2/31.6MM
LENGTH: 350MM
OFFSET: 23MM
WEIGHT: 287G (L350MM, Ø31.6MM)
COLOR: RED/GRAY

FALCON



FALCON ROAD ERGO BAR RA-519DB6-8

MATERIAL: AL6061
BARBOREØ: 31.8MM
WIDTH: 400/420/440MM
REACH: 70MM
DROP: 125MM
WEIGHT: 327G (420MM)
COLOR: RED/GRAY



NEW

FALCON ALLOY HEX SEATPOST SP-1540

MATERIAL: AL6061
POSTØ: 27.2/31.6MM
LENGTH: 350MM
OFFSET: 20/10/-5/-10MM
WEIGHT: 353G(TBD) (L350MM, Ø27.2MM)
COLOR: RED/GRAY



FALCON SEATPOST SP-1020

MATERIAL: AL6061
POSTØ: 27.2/31.6MM
LENGTH: 300/350/400MM
OFFSET: 20MM
WEIGHT: 270G (L300MM, Ø27.2MM)
COLOR: RED/GRAY



FALCON STEM RAS-88

MATERIAL: AL6061
HANDLEBARØ: 31.8MM
STEERERØ: 28.6MM
LENGTH: 80/90/100/110/120/130MM
ANGLE: +/-5°
WEIGHT: 138G(90MM)
COLOR: RED/GRAY



FALCON STEM INTEGRATED SPACER HSS-14

MATERIAL: AL6061
HEIGHT: 10MM
WEIGHT: 10G





**FALCON CLIP-ON BAR (U BEND)
TTH-14**

MATERIAL: AL6061
 LENGTH: MAX. 190MM, MIN. 160MM
 ARMREST'S +/- ADJUSTABLE ANGLE: 15°(+/-7.5°)
 ARMREST'S R / L ADJUSTABLE : R/30MM, L/30MM
 CLAMPØ: 31.8MM
 WEIGHT: 407G (WITH PAD)
 COLOR: RED/GRAY



**FALCON TT BAR(J BEND)
TTH-16**

MATERIAL: AL6061
 LENGTH: MAX. 303MM(C TO TOP) , MIN. 253MM
 EXTENSION BAR: J BAR, UP(C TO C) 55MM
 ARMREST'S R / L ADJUSTABLE : R/30MM, L/30MM
 ARMREST'S +/- ADJUSTABLE ANGLE: 15°(+/-7.5°)
 OPTION: SPACERS 20MM OR 40MM OR 60MM
 WEIGHT: 462G (WITH PAD)
 COLOR: RED/GRAY



**FALCON TT BAR(S BEND)
TTH-15**

MATERIAL: AL6061
 LENGTH: MAX. 303MM(Clamp center to top)
 MIN. 253MM
 EXTENSION BAR: S bar, rise 29MM
 ARMREST'S R / L ADJUSTABLE : R/30MM, L/30MM
 ARMREST'S +/- ADJUSTABLE ANGLE: 15°(+/-7.5°)
 OPTION: SPACERS 20MM OR 40MM OR 60MM
 WEIGHT: 450G (WITH PAD)
 COLOR: RED/GRAY



**PAD
TTH-15P**



**NEW
FALCON SPEED SADDLE
SD-22**

MATERIAL: POLYPROPYLENE+ALLOY
 LENGTH: 275MM
 WIDTH: 145MM
 WEIGHT: 285G
 COLOR: GRAY



**FALCON WATER BOTTLE
WBT-05**

MATERIAL: PLASTIC BOTTLE
 WEIGHT: 71G
 VOLUME: 600ML
 COLOR: RED/GRAY



**FALCON BOTTLE CAGE
BC-33**

MATERIAL: PLASTIC BOTTLE CAGE
 (MATTE BLACK STANDARD)
 WEIGHT: 30G
 COLOR: RED / GRAY



**FALCON REAR HYDRATION SYSTEMS
BC-31**

MATERIAL: AL6061 + PLASTIC
 WEIGHT: 202G
 MULTIFUNCTION ADJUSTMENTS
 (ANGLE UP TO 45 ° / HEIGHT UP TO 30MM)
 DOUBLE OR SINGLE WATER BOTTLE RACK AVAILABLE
 COLOR: RED/GRAY

ONE



ONE ROUND BAR RA-492DB68

MATERIAL: AL6061
 BARBOREØ: 31.8MM
 WIDTH: 360/380/400/420/440MM
 REACH: 70MM(W360-380MM)
 75MM(W400-440MM)
 DROP: 125MM (W360-380MM)
 128MM (W400-440MM)
 WEIGHT: 305G (420MM)
 COLOR: DECAL/LASER



ONE DROP STEM RAS-217

MATERIAL: AL6061
 HANDLEBARØ: 31.8MM
 STEERERØ: 28.6MM
 LENGTH: 70/80/90/100/110/120MM
 ANGLE: +/- 17°
 WEIGHT: 130G (100MM)
 COLOR: DECAL/LASER



ONE STEM RAS-80

MATERIAL: AL6061
 HANDLEBARØ: 31.8MM
 STEERERØ: 28.6MM
 LENGTH: 60/70/80/90/100/110/120/130MM
 ANGLE: +/- 5°
 WEIGHT: 121G (90MM)
 COLOR: DECAL/LASER



ONE ROAD BAR RA-473DB6-8

MATERIAL: AL6061
 BARBOREØ: 31.8MM
 WIDTH: 380/400/420/440MM
 REACH: 78MM
 DROP: 140MM
 WEIGHT: 305G (420MM)
 COLOR: DECAL/LASER



ONE SEATPOST SP-1080

MATERIAL: AL6061
 POSTØ: 27.2/30.9/31.6MM
 LENGTH: 350/400MM
 OFFSET: 10MM
 WEIGHT: 285G (L350MM, Ø27.2MM)
 COLOR: DECAL/LASER

ROAD COLLECTION SPEC

STEM	COUGAR AERO	COUGAR	TIMANIA	TUX	EXL	SLA	CLS	CLS DROP	FALCON	ONE	ONE DROP
ANGLE	-6°	-5°	±5°	±5°	±5°	±5°	±5°	±17°	±5°	±5°	±17°
40											
45											
50											
60					V		V			V	
70			V	V	V	V	V	V		V	V
80	V			V	V	V	V	V	V	V	V
90	V	V	V	V	V	V	V	V	V	V	V
100	V	V	V	V	V	V	V	V	V	V	V
110	V	V	V	V	V	V	V	V	V	V	V
120		V	V	V	V	V	V	V	V	V	V
130				V	V	V		V	V		
STACK HEIGHT(MM)	36	35	40	40	40	40	40	40	30.5	40	40
STEERER Ø(MM)	28.6	28.6	28.6	28.6	28.6	28.6	28.6	28.6	28.6	28.6	28.6
BARBORE Ø(MM)	31.8	31.8	31.8	31.8	31.8	31.8	31.8	31.8	31.8	31.8	31.8
BODY	AL6061	AL6061	MONOCOQUE TITANIUM	AL7075+ CARBON	AL6061+ CARBON	AL7075	AL6061	AL6061	AL6061	AL6061	AL6061
FACEPLATE	AL6061	AL6061	6AL-4V TITANIUM	AL7075+ CARBON	AL6061	AL7075	AL6061	AL6061	AL6061	AL6061	AL6061
BOLT	SCM-435	SCM-435	6AL-4V TITANIUM	STAINLESS STEEL	SCM-435	STAINLESS STEEL	SCM-435	SCM-435	SCM-435	SCM-435	SCM-435
LOGO APPLICATION	COLOR DECAL	COLOR DECAL	LASER	COLOR DECAL	COLOR DECAL	COLOR DECAL	COLOR DECAL	COLOR DECAL	COLOR DECAL	DECAL/LASER	DECAL/LASER
FINISH	SB BLACK	SB BLACK	TITANIUM	UD	UD	SB BLACK	SB BLACK	SB BLACK	SB BLACK	SB BLACK	SB BLACK
WEIGHT	220G (100MM)	182G (110MM)	135G (100MM)	115G (90MM)	133G (90MM)	107G (90MM)	113G (100MM)	109G (70MM)	138G (90MM)	121G (90MM)	130G (100MM)

ROAD BARS

	COUGAR CARBON	COUGAR ALLOY	TIMANIA ROAD	TUX COMPACT	TUX ROAD	EXL COMPACT	EXL GRAVEL	EXL GRAVEL COMPACT	EXL ROAD	SLA COMPACT	SLA ERGO
BARBORE	31.8	31.8	31.8	31.8	31.8	31.8	31.8	31.8	31.8	31.8	31.8
360											
380									V		V
400	V	V	V	V	V	V	V	V	V	V	V
420	V	V	V	V	V	V	V	V	V	V	V
440	V	V	V	V	V	V	V	V	V	V	V
460											
DROP(MM)	125	125	130	125	140	125	145	125	124(380-400) 126(420-440)	125	125
REACH	78	78	75	75	78	75	75	75	70	75	70
OUTWARD BEND	4°	4°		4°		4°	16°	16°		4°	
BACK SWEEP							6°	6°			
RISE							20	20			
CABLE ROUTING	GROOVE	GROOVE	GROOVE	GROOVE	GROOVE	GROOVE	GROOVE	GROOVE	GROOVE	GROOVE	GROOVE
MATERIAL	CARBON	AL6061	TI+CARBON	CARBON	CARBON	CARBON	CARBON	CARBON	CARBON	AL7050	AL7050
LOGO APPLICATION	COLOR DECAL	COLOR DECAL	DECAL+LASER	COLOR DECAL	COLOR DECAL	COLOR DECAL	COLOR DECAL	COLOR DECAL	COLOR DECAL	COLOR DECAL	COLOR DECAL
FINISH	UD	SB BLACK	TITANIUM	UD	UD	UD	UD	UD	UD	SB BLACK	SB BLACK
WEIGHT	237G (420MM)	310G (420MM)	240G (420MM)	169G (420MM)	186G (420MM)	205G (420MM)	230G (420MM)	230G (420MM)(TBD)	220G (420MM)	250G (420MM)	270G (400MM)
NOTES	HMS BENDING	HMS BENDING	HMS BENDING	HMS BENDING	HMS BENDING	HMS BENDING	HMS BENDING	HMS BENDING	HMS BENDING	HMS BENDING	HMS BENDING

	CLS COMPACT	CLS GRAVEL RISER	CLS ROAD RISER	CLS ROAD	CLS GRAVEL	FALCON ERGO	ONE ROUND	ONE ROAD
BARBORE	31.8	31.8	31.8	31.8	31.8	31.8	31.8	31.8
360							V	
380				V			V	V
400	V	V	V	V	V	V	V	V
420	V	V	V	V	V	V	V	V
440	V	V	V	V	V	V	V	V
460					V			
DROP(MM)	125	125	125	124(380-400) 126(420-440)	130	125	125(360-380) 128(400-440)	140
REACH	75	75	75	70	75	70	70	78
OUTWARD BEND	4°	16°	4°		12°			
BACK SWEEP								
RISE		20	20					
CABLE ROUTING	GROOVE	GROOVE	GROOVE	GROOVE	GROOVE	GROOVE	GROOVE	GROOVE
MATERIAL	AL6061	AL6061	AL6061	AL6061	AL6061	AL6061	AL6061	AL6061
LOGO APPLICATION	COLOR DECAL	COLOR DECAL	COLOR DECAL	COLOR DECAL	COLOR DECAL	COLOR DECAL	DECAL/LASER	DECAL/LASER
FINISH	SB BLACK	SB BLACK	SB BLACK	SB BLACK	SB BLACK	SB BLACK	SB BLACK	SB BLACK
WEIGHT	290G (420MM)	315G (420MM)(TBD)	315G (420MM)(TBD)	290G (420MM)	305G (440MM)	327G (420MM)	305G (420MM)	305G (420MM)
NOTES	HMS BENDING	HMS BENDING	HMS BENDING	HMS BENDING	HMS BENDING	HMS BENDING	HMS BENDING	HMS BENDING

SEATPOST

	COUGAR HEX	TIMANIA OFFSET	TUX OFFSET	TUX 10MM OFFSET	EXL LIGHT	EXL 10MM OFFSET	EXL 23MM OFFSET	SLA LIGHT	SLA 10MM OFFSET	SLA 23MM OFFSET	
LENGTH (MM)	250										
	300										
	350	V	V	V			V	V	V	V	
	400				V	V			V		
	410										
DIAMETER (MM)	27.2	V	V	V	V	V	V	V	V	V	
	30.9					V			V		
	31.6	V	V	V	V	V	V	V	V	V	
SET BACK(MM)	20/10/-3/-6	12	24	10	12	10	23	12	10	23	
MATERIAL	TUBE	CARBON	3AL-2.5V TITANIUM	CARBON	CARBON	CARBON	CARBON	CARBON	AL7050	AL7075	AL2014
	CLAMP	AL6061	AL7075	AL2014	AL2014	AL7075	AL2014	AL2014	AL7075	AL2014	AL2014
	BOLT	SCM-435	6AL-4V TITANIUM	STAINLESS STEEL	STAINLESS STEEL	AL7075	STAINLESS STEEL	STAINLESS STEEL	AL7075	STAINLESS STEEL	STAINLESS STEEL
LOGO APPLICATION	COLOR DECAL	LASER	COLOR DECAL	COLOR DECAL	COLOR DECAL	COLOR DECAL	COLOR DECAL	COLOR DECAL	COLOR DECAL	COLOR DECAL	COLOR DECAL
FINISH	UD	TITANIUM	UD	UD	UD	UD	UD	SB BLACK	SB BLACK	SB BLACK	
WEIGHT	253G (L350/Ø27.2) (TBD)	199G (L350/Ø31.6)	184G (L350/Ø27.2)	195G (L350/Ø31.6)	180G (L350/Ø27.2)	226G (L350/Ø27.2)	244G (L350/Ø27.2)	195G (L350/Ø27.2)	242G (L350/Ø27.2)	242G (L350/Ø27.2)	

	CLS 10MM OFFSET	CLS 23MM OFFSET	FALCON HEX	FALCON	ONE	
LENGTH (MM)	250					
	300			V		
	350	V	V	V	V	
	400				V	V
	410					
DIAMETER (MM)	27.2	V	V	V	V	
	30.9				V	
	31.6	V	V	V	V	
SET BACK(MM)	10	23	20/10/-3/-6	20	10	
MATERIAL	TUBE	AL6061	AL6061	AL6061	AL6061	AL6061
	CLAMP	AL2014	AL2014	AL6061	AL2014	AL2014
	BOLT	STAINLESS STEEL	STAINLESS STEEL	SCM-435	STAINLESS STEEL	STAINLESS STEEL
LOGO APPLICATION	COLOR DECAL	COLOR DECAL	COLOR DECAL	COLOR DECAL	DECAL/LASER	
FINISH	SB BLACK	SB BLACK	SB BLACK	SB BLACK	SB BLACK	
WEIGHT	285G (L350/Ø27.2)	287G (L350/Ø31.6)	353G (L350/Ø27.2) (TBD)	270G (L300/Ø27.2)	285G (L350/Ø27.2)	

WHEELS

	TUX R45 TU	TUX R45 TU DISC	TUX R45 CL	TUX R45 CL DISC
HUB	F:100x15mm R:142x12mm			
SPOKES	SAPIM CX RAY AERO	SAPIM CX RAY AERO	SAPIM CX RAY AERO	SAPIM CX RAY AERO
RIM DEPTH	45MM	45MM	45MM	45MM
RIM WIDTH	25MM	25MM	23.5MM	23.5MM
WEIGHT	1350G	1480G	1520G	1650G

FORKS

	COUGAR	TUX
BIKE TYPE	700C	700C
STEERER	UP 1-1/8" DOWN 1-1/2"	UP 1-1/8" DOWN 1-1/2"
CROWN	57MM	56MM
CROWN RACE	39.8MM	39.8MM
OFFSET	43MM	45MM
MATERIAL	CARBON	CARBON
WEIGHT	485G	400G

SEAT CLAMPS

	TIMANIA
MATERIAL	6AL-4V TITANIUM
ID	31.8MM/34.9MM
WEIGHT	20G(34.9MM)

SPACERS

	TIMANIA	FALCON
HEIGHT	5/10/15MM	10MM
WEIGHT	2.5/4/7G	10G





MTB ELEMENTS

COMPARISON

CONTROLTECH	SHIMANO	SRAM	FSA	RACEFACE
TUX	XTR	XX	K-FORCE Light	NEXT
EXL	XT	X0	SL-K	SIXC
SLA	SLX	X9	Afterburner	TURBINE
CLS / LYNX 35 / MST 35	SLX	X7	V-Drive	ATLAS / AFFECT
ONE	ALIVIO		Comet	RESPOND
			OMEGA	

TIMANIA



NEW

TIMANIA FLAT TOP BAR ATB-302

MATERIAL: 3AL-2.5V
BARBOREØ: 31.8MM
WIDTH: 720/760MM
BACK SWEEP: 9°
WEIGHT: 275G(760MM)



TIMANIA FLAT BAR ATB-257

MATERIAL: 3AL-2.5V TITANIUM
BARBOREØ: 31.8MM
LENGTH: 660/720MM
BACK SWEEP: 5° (660MM), 9° (720MM)
WEIGHT: 225G (660MM)



TIMANIA RISER BAR ATB-297

MATERIAL: 3AL-2.5V TITANIUM
BARBOREØ: 31.8MM
LENGTH: 720/760MM
BACK SWEEP: 9°
UP SWEEP: 6°
RISE: 20MM
WEIGHT: 278G (720MM)



TIMANIA STEM ATB-937

MATERIAL: 6AL-4V TITANIUM
HANDLEBARØ: 31.8MM
STEERERØ: 28.6MM
LENGTH: 70/90/100/110/120MM
ANGLE: +/-5°
WEIGHT: 135G (100MM)



TIMANIA SPACERS HSS-12

MATERIAL: TITANIUM
HEIGHT: 5/10/15MM
WEIGHT: 2.3/4.3/7.3G



TIMANIA STEM CAP CAP-44

MATERIAL: TITANIUM
STEERER: 23.3-25.4MM
BOLT: ALUMINUM
WEIGHT: 34G

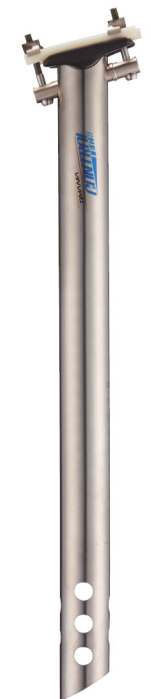

TIMANIA ZERO OFFSET SEATPOST SP-1190

MATERIAL: 3AL-2.5V TITANIUM
POSTØ: 27.2/31.6MM
LENGTH: 350/400MM
OFFSET: 0MM
WEIGHT: 234G (L400MM, Ø31.6MM)

TUX



**TUX FLAT BAR
ATB-223-8UD**

MATERIAL: UD CARBON
BARBOREØ: 31.8MM
LENGTH: 600MM
BACK SWEEP: 6°
WEIGHT: 120G(600MM)
COLOR: RED/GRAY



**TUX RISER BAR
ATB-259-8UD**

MATERIAL: UD CARBON
BARBOREØ: 31.8MM
LENGTH: 710/760MM
BACK SWEEP: 9°
UP SWEEP: 4°
RISE: 20MM
WEIGHT: 160G(710MM)
COLOR: RED/GRAY



**TUX FLAT TOP BAR
ATB-300-8UD**

MATERIAL: UD CARBON
BARBOREØ: 31.8MM
LENGTH: 720/760MM
BACK SWEEP: 9°
WEIGHT: 145G (720MM)
COLOR: RED/GRAY



**TUX SL FLAT BAR
(FOR CROSS COUNTRY ONLY)
ATB-287-8UD**

MATERIAL: UD CARBON
BARBOREØ: 31.8MM
LENGTH: 720MM
BACK SWEEP: 9°
WEIGHT: 117G(720MM)
FOR CYCLECROSS ONLY
COLOR: RED/GRAY



**TUX SL RISER BAR
(FOR CROSS COUNTRY ONLY)
ATB-288-8UD**

MATERIAL: UD CARBON
BARBOREØ: 31.8MM
LENGTH: 720MM
BACK SWEEP: 9°
UP SWEEP: 6°
RISE: 20MM
WEIGHT: 125G(720MM)
COLOR: RED/GRAY



**TUX STEM
RAS-79-FUD**

MATERIAL: UD CARBON+AL7075
HANDLEBARØ: 31.8MM
STEERERØ: 28.6MM
LENGTH: 70/80/90/100/110/120/130MM
ANGLE: +/- 5°
WEIGHT: 115G (90MM)
COLOR: RED/GRAY



**TUX ZERO OFFSET SEATPOST
SP-1210**

MATERIAL: UD CARBON
POSTØ: 31.6MM
LENGTH: 410MM
OFFSET: 0MM
WEIGHT: 192G (L410MM, Ø31.6MM)
COLOR: RED/GRAY



**TUX 0MM OFFSET SEATPOST
SP-1430**

MATERIAL: UD CARBON
POSTØ: 27.2/30.9/31.6MM
LENGTH: 400MM
OFFSET: 0MM
WEIGHT: 205G (L400MM, Ø31.6MM)
COLOR: RED/GRAY

EXL



EXL FLAT TOP BAR ATB-274-8UD

MATERIAL: UD CARBON
BARBOREØ: 31.8MM
LENGTH: 700/760MM
BACK SWEEP: 9°
UP SWEEP: 4°
WEIGHT: 198G(700MM)
COLOR: RED/GRAY



EXL RISER BAR ATB-275-8UD

MATERIAL: UD CARBON
BARBOREØ: 31.8MM
LENGTH: 710/750MM
BACK SWEEP: 9°
UP SWEEP: 4°
RISE: 20MM
WEIGHT: 208G(710MM)
COLOR: RED/GRAY



EXL STEM RAS-82-FUD

MATERIAL: AL6061+UD CARBON
HANDLEBARØ: 31.8MM
STEERERØ: 28.6MM
LENGTH: 60/70/80/90/100/110/120/130MM
ANGLE: +/- 5°
WEIGHT: 133G (90MM)
COLOR: RED/GRAY



EXL 0mm OFFSET SEATPOST SP-1270UD

MATERIAL: UD CARBON
POSTØ: 27.2/30.9/31.6MM
LENGTH: 350/400MM
OFFSET: 0MM
WEIGHT: 207G (L350MM, Ø27.2MM)
COLOR: RED/GRAY



EXL 10mm OFFSET SEATPOST SP-1280UD

MATERIAL: UD CARBON
POSTØ: 27.2/30.9/31.6MM
LENGTH: 350/400MM
OFFSET: 10MM
WEIGHT: 253.5G(L350MM, Ø31.6MM)
COLOR: RED/GRAY

SLA



SLA FLAT BAR ATB-262DB7-8

MATERIAL: AL7075
BARBOREØ: 31.8MM
LENGTH: 700MM
BACK SWEEP: 9°
WEIGHT: 248G (700MM)
COLOR: RED/GRAY



SLA FLAT TOP BAR ATB-281DB7-8

MATERIAL: AL7050
BARBOREØ: 31.8MM
LENGTH: 700/760MM
BACK SWEEP: 9°
WEIGHT: 256G (700MM)
COLOR: RED/GRAY



SLA RISER BAR ATB-284DB7-8

MATERIAL: AL7050
BARBOREØ: 31.8MM
LENGTH: 710/750MM
BACK SWEEP: 9°
UP SWEEP: 4°
RISE: 15MM
WEIGHT: 250G (710MM)
COLOR: RED/GRAY



SLA STEM RAS-85

MATERIAL: AL7075
HANDLEBARØ: 31.8MM
STEERERØ: 28.6MM
LENGTH: 70/80/90/100/110/120/130MM
ANGLE: +/- 5°
WEIGHT: 107G (90MM)
COLOR: RED/GRAY



SLA ZERO OFFSET SEATPOST SP-997

MATERIAL: AL7075
POSTØ: 27.2/30.9/31.6MM
LENGTH: 350/400MM
OFFSET: 0MM
WEIGHT: 270G (L400MM, Ø31.6MM)
COLOR: RED/GRAY



SLA 10mm OFFSET SEATPOST SP-988

MATERIAL: AL7075
POSTØ: 27.2/30.9/31.6MM
LENGTH: 350/400MM
OFFSET: 10MM
WEIGHT: 242G (L350MM, Ø27.2MM)
COLOR: RED/GRAY



**CLS FLAT TOP BAR
ATB-281DB6-8**

MATERIA: AL6061
BARBOREØ: 31.8MM
LENGTH: 700/760MM
BACK SWEEP: 9°
WEIGHT: 268G (700MM)
COLOR: RED/GRAY



**CLS RISER BAR
ATB-284DB6-8**

MATERIAL: AL6061
BARBOREØ: 31.8MM
LENGTH: 710/750MM
BACK SWEEP: 9°
UP SWEEP: 4°
RISE: 15MM
WEIGHT: 306G (710MM)
COLOR: RED/GRAY



**CLS DROP STEM
RAS-117**

MATERIAL: AL6061
HANDLEBARØ: 31.8MM
STEERERØ: 28.6MM
LENGTH: 70/80/90/100/110/120MM
ANGLE: +/- 17°
WEIGHT: 109G (70MM)
COLOR: RED/GRAY



**CLS STEM
RAS-110**

MATERIAL: AL6061
HANDLEBARØ: 31.8MM
STEERERØ: 28.6MM
LENGTH: 60/70/80/90/100/110/120MM
ANGLE: +/- 5°
WEIGHT: 113G(100MM)
COLOR: RED/GRAY



**CLS ZERO OFFSET SEATPOST
SP-1420**

MATERIAL: AL6061
POSTØ: 27.2/30.9/31.6MM
LENGTH: 400MM
OFFSET: 0MM
WEIGHT: 289G (L400MM, Ø31.6MM)
COLOR: RED/GRAY



**CLS 10mm OFFSET SEATPOST
SP-1180**

MATERIAL: AL6061
POSTØ: 27.2/31.6MM
LENGTH: 350MM
OFFSET: 10MM
WEIGHT: 285G (L350MM, Ø27.2MM)
COLOR: RED/GRAY

LYNX



**LYNX 35 FLAT TOP BAR
ATB-382DB6-5**

MATERIAL: AL6061
BARBOREØ: 35MM
LENGTH: 710/760/800MM
BACK SWEEP: 9°
WEIGHT: 296G (710MM)
COLOR: RED/GRAY



**LYNX 35 RISER BAR
ATB-383DB6-5**

MATERIAL: AL6061
BARBOREØ: 35MM
LENGTH: 750/800MM
BACK SWEEP: 9°
UP SWEEP: 4°
RISE: 20MM
WEIGHT: 310G (750MM)
COLOR: RED/GRAY



**NEW LYNX 31.8 DI2 FLAT TOP BAR
ATB-381DB6-DI2**
**LYNX 31.8 FLAT TOP BAR
ATB-381DB6**

MATERIAL: AL6061
BARBOREØ: 31.8MM
LENGTH: 700/760/800MM
BACK SWEEP: 9°
WEIGHT: 268G (700MM)
307G (760MM/DI2)
COLOR: RED/GRAY
COMPATIBLE WITH SHIMANO MTB DI2 SYSTEM



**NEW LYNX 31.8 DI2 RISER BAR
ATB-384DB6-DI2**
**LYNX 31.8 RISER BAR
ATB-384DB6**

MATERIAL: AL6061
BARBOREØ: 31.8MM
LENGTH: 710/750/800MM
BACK SWEEP: 9°
UP SWEEP: 4°
RISE: 15MM
WEIGHT: 306G (710MM)
316G (750MM/DI2)
COLOR: RED/GRAY
COMPATIBLE WITH SHIMANO MTB DI2 SYSTEM



**NEW LYNX DI2 STEM
RAS-96DI2**

MATERIAL: AL6061
HANDLEBARØ: 31.8MM
STEERERØ: 28.6MM
LENGTH: 60/70MM
ANGLE: -5°
WEIGHT: 123G(60MM)(TBD)
IDEAL FOR ALL MOUNTAIN & ENDURO 27.5 AND 29ER
COLOR: RED/GRAY
COMPATIBLE WITH SHIMANO MTB DI2 SYSTEM

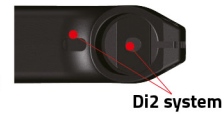

**LYNX 31.8 STEM
ATB-956**

MATERIAL: AL6061
CLAMP SIZE: 31.8MM
STEERERØ: 28.6MM
LENGTH: 40/50MM
ANGLE: +/- 0°
WEIGHT: 139G (40MM)
IDEAL FOR ALL MOUNTAIN & ENDURO 27.5 AND 29ER
COLOR: RED/GRAY



**LYNX 35 STEM
ATB-957**

MATERIAL: AL6061
CLAMP SIZE: 35MM
STEERERØ: 28.6MM
LENGTH: 40/50MM
ANGLE: +/- 0°
WEIGHT: 162G(40MM)
IDEAL FOR ALL MOUNTAIN & ENDURO 27.5 AND 29ER
COLOR: RED/GRAY

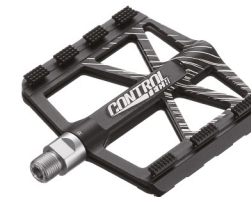

**LYNX PEDAL
PD-04**

MATERIAL: AL6061
PLATFORM: 100MM X 104MM
CNC CR-MO AXLE WITH/ 3 SEALED BEARINGS
WEIGHT: 388G
INTEGRATED THREADLESS PEG DESIGN
IS LIGHTWEIGHT AND RELIABLE



**NEW LYNX SADDLE
SD-23**

MATERIAL: POLYPROPYLENE+ALLOY
LENGTH: 275MM
WIDTH: 145MM
WEIGHT: 285G
COLOR: GRAY



**LYNX HUB
HUB-41**

MATERIAL: AL6061
FRONT HUB: 100X15MM, 32 HOLES, 2 BEARINGS
REAR HUB: 142X12MM, 32 HOLES, 4 BEARINGS
WEIGHT: F 199G/R 236G
TOOLLESS CASSETTE BODY REMOVAL FOR EASY MAINTENANCE
COMPATIBLE WITH SHIMANO 11S/SRAM 10S & XD 11S
CONICAL HUBSHELL IS LIGHT, STRONG AND ROBUST FOR OFFLOAD ABUSE
6-HOLE DISC ROTOR COMPATIBILITY



**NEW LYNX DROPPER SEATPOST
SP-1530**

MATERIAL: AL6066
POSTØ: 30.9/31.6MM
TRAVEL: 125/150MM
WEIGHT: 590G
(TRAVEL 125MM, Ø31.6MM)

LYNX wheels



LYNX 27.5ER RIM-71 LYNX 29ER RIM-72

FRONT HUB CNC AL6061: 100X15MM, 32 HOLES, 2 BEARINGS
REAR HUB CNC AL6061: 142X12MM, 32 HOLES, 4 BEARINGS
RIM DEPTH: 21MM
RIM WIDTH: 24MM
WEIGHT: 27.5ER 1535G / 29ER 1669G
COLOR: RED/GRAY

TUBELESS READY RIM PROFILE
SAPIM RACE 2.0/1.8/2.0 DOUBLE BUTTED ROUND SPOKES
TOOLLESS CASSETTE BODY REMOVAL FOR EASY MAINTENANCE

COMPATIBLE WITH SHIMANO 11S/SRAM 10S & XD 11S

LYNX 27.5 PLUS RIM-73

FRONT HUB CNC AL6061: 110X15MM, 32 HOLES, 2 BEARINGS
REAR HUB CNC AL6061: 148X12MM, 32 HOLES, 4 BEARINGS
RIM DEPTH: 18MM
RIM WIDTH: 40MM
WEIGHT: 1771G
COLOR: RED/GRAY

TUBELESS READY RIM PROFILE
SAPIM RACE 2.0/1.8/2.0 DOUBLE BUTTED ROUND SPOKES
TOOLLESS CASSETTE BODY REMOVAL FOR EASY MAINTENANCE

COMPATIBLE WITH SHIMANO 11S/SRAM 10S & XD 11S





**MST CARBON FLAT TOP BAR
ATB-293UD**

MATERIAL: UD CARBON
BARBOREØ: 35MM
LENGTH: 710/760/800MM
BACK SWEEP: 9°
WEIGHT: 215G (760MM)
COLOR: RED/GRAY



**MST CARBON RISER BAR
ATB-294UD**

MATERIAL: UD CARBON
BARBOREØ: 35MM
LENGTH: 750/800MM
BACK SWEEP: 9°
UP SWEEP: 4°
RISE: 20MM
WEIGHT: 235G (750MM)
COLOR: RED/GRAY



**MST ALLOY FLAT TOP BAR
ATB-282DB6-5
ATB-282DB7-5**

MATERIAL: AL7050/AL6061
BARBOREØ: 35MM
LENGTH: 710/760/800MM
BACK SWEEP: 9°
WEIGHT: 264G (710MM AL7050)
296G (710MM AL6061)
COLOR: RED/GRAY



**MST STEM
ATB-949**

MATERIAL: AL6061
HANDLEBARØ: 35,0MM
STEERERØ: 28,6MM
LENGTH: 50/60/70/80MM
ANGLE: +/- 0°
WEIGHT: 146G (60MM)
COLOR: RED/GRAY



**MST SEATPOST
SP-1220-6
SP-1220-7**

MATERIAL: AL7050/AL6061
POSTØ: 27.2/30.9/31.6MM
LENGTH: 400MM
OFFSET: 0MM
WEIGHT: AL7050 255G (L400MM, Ø31.6MM)
AL6061 289G (L400MM, Ø31.6MM)
COLOR: RED/GRAY



**MST ALLOY RISER BAR
ATB-283DB6-5
ATB-283DB7-5**

MATERIAL: AL7050/AL6061
BARBOREØ: 35MM
LENGTH: 750/800MM
BACK SWEEP: 9°
UP SWEEP: 4°
RISE: 20MM
WEIGHT: 276G (750MM AL7050)
310G (750MM AL6061)
COLOR: RED/GRAY

ONE



ONE FLAT BAR ATB-210DB6-8

MATERIAL: AL6061
BARBOREØ: 31.8MM
LENGTH: 600/700/760MM
BACK SWEEP: 6° (LENGTH: 600MM)
BACK SWEEP: 9° (LENGTH: 700/760MM)
WEIGHT: 234G (W600MM)
COLOR: DECAL/LASER



ONE RISER BAR ATB-213DB6-8

MATERIAL: AL6061
BARBOREØ: 31.8MM
LENGTH: 660/700MM
BACK SWEEP: 6° (LENGTH: 660MM)
BACK SWEEP: 9° (LENGTH: 700MM)
UP SWEEP: 5° (LENGTH: 660/700MM)
RISE: 20MM
WEIGHT: 293G (660MM)
COLOR: DECAL/LASER



ONE DROP STEM RAS-217

MATERIAL: AL6061
HANDLEBARØ: 31.8MM
STEERERØ: 28.6MM
LENGTH: 70/80/90/100/110/120MM
ANGLE: +/- 17°
WEIGHT: 130G (100MM)
COLOR: DECAL/LASER



ONE STEM RAS-80

MATERIAL: AL6061
HANDLEBARØ: 31.8MM
STEERERØ: 28.6MM
LENGTH: 60/70/80/90/100/110/120/130MM
ANGLE: +/- 5°
WEIGHT: 121G (90MM)
COLOR: DECAL/LASER



ONE SEATPOST SP-1080

MATERIAL: AL6061
POSTØ: 27.2/30.9/31.6MM
LENGTH: 350/400MM
OFFSET: 10MM
WEIGHT: 285G (L350MM, Ø27.2MM)
COLOR: DECAL/LASER

MTB COLLECTION SPEC

STEM

	TIMANIA	TUX	EXL	SLA	CLS	CLS DROP	LYNX 35	LYNX 31.8	LYNX Di2	MST	ONE	ONE DROP
ANGLE	±5°	±5°	±5°	±5°	±5°	±17°	±0°	±0°	-5°	±0°	±5°	±17°
40							V	V				
45												
50							V	V		V		
60			V		V				V	V	V	
70	V	V	V	V	V	V			V	V	V	V
80		V	V	V	V	V				V	V	V
90	V	V	V	V	V	V					V	V
100	V	V	V	V	V	V					V	V
110	V	V	V	V	V	V					V	V
120	V	V	V	V	V	V					V	V
130		V	V	V							V	
STACK HEIGHT(MM)	40	40	40	40	40	40	43	41	35	42	40	40
STEERER Ø(MM)	28.6	28.6	28.6	28.6	28.6	28.6	28.6	28.6	28.6	28.6	28.6	28.6
BARBORE Ø(MM)	31.8	31.8	31.8	31.8	31.8	31.8	35	31.8	31.8	35	31.8	31.8
BODY	MONOCOQUE TITANIUM	AL7075+ CARBON	AL6061+ CARBON	AL7075	AL6061	AL6061	AL6061	AL6061	AL6061	AL6061	AL6061	AL6061
FACEPLATE	6AL-4V TITANIUM	AL7075+ CARBON	AL6061	AL7075	AL6061	AL6061	AL6061	AL6061	AL6061	AL6061	AL6061	AL6061
BOLT	TITANIUM	STAINLESS STEEL	SCM-435	STAINLESS STEEL	SCM-435	SCM-435	SCM-435	SCM-435	SCM-435	STAINLESS STEEL	SCM-435	SCM-435
LOGO APPLICATION	LASER	COLOR DECAL	COLOR DECAL	COLOR DECAL	COLOR DECAL	COLOR DECAL	COLOR DECAL	COLOR DECAL	COLOR DECAL	COLOR DECAL	DECAL/LASER	DECAL/LASER
FINISH	TITANIUM	UD	UD	SB BLACK	SB BLACK	SB BLACK	SB BLACK	SB BLACK	SB BLACK	SB BLACK	SB BLACK	SB BLACK
WEIGHT	135G (100MM)	115G (90MM)	133G (90MM)	107G (90MM)	113G (100MM)	109G (70MM)	162G (40MM)	139G (40MM)	123G (60MM)(TBD)	146G (60MM)	121G (90MM)	130G (100MM)

MTB BARS

	TIMANIA FLAT TOP	TIMANIA FLAT	TIMANIA RISER	TUX FLAT	TUX RISER	TUX FLAT TOP	TUX SL FLAT	TUX SL RISER	EXL FLAT TOP	EXL RISER	SLA FLAT	SLA FLAT TOP	SLA RISER
BARBORE	31.8	31.8	31.8	31.8	31.8	31.8	31.8	31.8	31.8	31.8	31.8	31.8	31.8
600				V									
640													
660		V											
680													
690													
700									V		V	V	
710					V					V			V
720	V	V	V			V	V	V					
750										V			V
760	V		V		V	V			V			V	
780													
800													
BACK SWEEP	9°	5°(W660) 9°(W720)	9°	6°	9°	9°	9°	9°	9°	9°	9°	9°	9°
UP SWEEP	0°	0°	6°	0°	4°	0°	0°	6°	4°	4°	0°	0°	4°
RISE(MM)	0	0	20	0	20	0	0	20	0	20	0	0	15
MATERIAL	3AL-2.5V TITANIUM	3AL-2.5V TITANIUM	3AL-2.5V TITANIUM	CARBON	CARBON	CARBON	CARBON	CARBON	CARBON	CARBON	AL7075	AL7050	AL7050
LOGO APPLICATION	LASER	LASER	LASER	COLOR DECAL	COLOR DECAL	COLOR DECAL	COLOR DECAL	COLOR DECAL	COLOR DECAL	COLOR DECAL	COLOR DECAL	COLOR DECAL	COLOR DECAL
FINISH	TITANIUM	TITANIUM	TITANIUM	UD	UD	UD	UD	UD	UD	UD	SB BLACK	SB BLACK	SB BLACK
WEIGHT	275 (760MM)	225G (660MM)	278G (720MM)	120G (600MM)	160G (710MM)	145G (720MM)	117G	125G	198G (700MM)	208G (710MM)	248G (700MM)	256G (700MM)	250G (710MM)

MTB BARS

	CLS FLAT TOP	CLS RISER	LYNX 35 FLAT TOP	LYNX 35 RISER	LYNX 31.8 FLAT TOP	LYNX 31.8 RISER	MST CB FLAT TOP	MST CB RISER	MST AL FLAT TOP	MST AL RISER	ONE FLAT	ONE RISER
BARBORE	31.8	31.8	35	35	31.8	31.8	35	35	35	35	31.8	31.8
600											V	
640												
660												V
680												
690												
700	V				V						V	V
710		V	V			V	V		V			
720												
750		V		V		V		V		V		
760	V		V		V		V		V		V	
780								V		V		
800			V	V	V	V	V		V			
BACK SWEEP	9°	9°	9°	9°	9°	9°	9°	9°	9°	9°	6°(W600) 9°(W700/600)	6°(W660) 9°(W700)
UP SWEEP	0°	4°	0°	4°	0°	4°	0°	4°	0°	4°	0°	5°(W660/700)
RISE(MM)	0	15	0	20	0	15	0	20	0	20	0	20
MATERIAL	AL6061	AL6061	AL6061	AL6061	AL6061	AL6061	CARBON	CARBON	AL7050 AL6061	AL7050 AL6061	AL6061	AL6061
LOGO APPLICATION	COLOR DECAL	COLOR DECAL	COLOR DECAL	COLOR DECAL	COLOR DECAL	COLOR DECAL	COLOR DECAL	COLOR DECAL	COLOR DECAL	COLOR DECAL	DECAL/LASER	DECAL/LASER
FINISH	SB BLACK	SB BLACK	SB BLACK	SB BLACK	SB BLACK	SB BLACK	UD	UD	SB BLACK	SB BLACK	SB BLACK	SB BLACK
WEIGHT	271G (700MM)	306G (710MM)	296G (710MM)	310G (750MM)	268G (700MM)	306G (710MM)	215G (760MM)	235G (750MM)	AL7050 264G (710MM) AL6061 296G (710MM)	AL7050 276G (750MM) AL6061 296G (710MM)	234G (600MM)	293G (660MM)

SEATPOST

SEATPOST		TIMANIA	TUX	TUX	EXL	EXL	SLA	SLA	CLS	CLS	LYNX	MST	ONE
		ZERO OFFSET	ZERO OFFSET	OMM OFFSET	OMM OFFSET	10MM OFFSET	OMM OFFSET	10MM OFFSET	ZERO OFFSET	10MM OFFSET	DROPPER		
LENGTH (MM)	250												
	300												
	350	V			V	V	V	V		V			V
	400	V		V	V	V	V	V	V			V	V
	410		V										
DIAMETER (MM)	421										V		
	27.2	V		V	V	V	V	V	V	V		V	V
	30.9			V	V	V	V	V			V	V	V
	31.6	V	V	V	V	V	V	V	V	V	V	V	V
SET BACK(MM)		0	0	0	0	10	0	10	0	10	0	0	10
TRAVEL(MM)		0	0	0	0	0	0	0	0	0	125/150	0	0
MATERIAL	TUBE	3AL-2.5V TITANIUM	CARBON	CARBON	CARBON	CARBON	AL7075	AL7075	AL6061	AL6061	AL6061	AL7050 AL6061	AL6061
	CLAMP	AL7075	AL2014	AL2014	AL2014	AL2014	AL2014	AL2014	AL2014	AL2014	AL6066	AL2014	AL2014
	BOLT	6AL-4V TITANIUM	STAINLESS STEEL	STAINLESS STEEL	STAINLESS STEEL	STAINLESS STEEL	STAINLESS STEEL	STAINLESS STEEL	STAINLESS STEEL	STAINLESS STEEL	SCM-435	STAINLESS STEEL	STAINLESS STEEL
LOGO APPLICATION		LASER	COLOR DECAL	COLOR DECAL	COLOR DECAL	COLOR DECAL	COLOR DECAL	COLOR DECAL	COLOR DECAL	COLOR DECAL	LASER	COLOR DECAL	DECAL/LASER
FINISH		TITANIUM	UD	UD	UD	UD	SB BLACK	SB BLACK	SB BLACK	SB BLACK	SB BLACK	SB BLACK	SB BLACK
WEIGHT		234G (L400/Ø31.6)	192G (L400/Ø31.6)	205G (L400/Ø31.6)	207G (L350/Ø27.2)	226G (L350/Ø27.2)	270G (L400/Ø31.6)	242G (L350/Ø27.2)	289G (L400/Ø31.6)	285G (L350/Ø27.2)	590G (L300/Ø27.2)	AL7050 255G (L400/Ø31.6) AL6061 289G (L350/Ø27.2)	285G (L350/Ø27.2)

WHEELS

	LYNX 27.5	LYNX 29	LYNX 27.5+
HUB	F:100x15mm R:142x12mm	F:100x15mm R:142x12mm	F:110x15mm R:148x12mm
SPOKES	SAPIM RACE 2.0/1.8/2.0 DOUBLE BUTTED ROUND		
RIM DEPTH	21MM	21MM	18MM
RIM WIDTH	24MM	24MM	40MM
WEIGHT	1535G	1669G	1771G

HUB

	LYNX
HUB	F:100x15mm / R:142x12mm 32 HOLES F & R
MATERIAL	AL6061
WEIGHT	F:199G / R:236G

SEAT CLAMPS

	TIMANIA
MATERIAL	6AL-4V TITANIUM
ID	31.8MM/34.9MM
WEIGHT	20G(34.9MM)

SPACERS

	TIMANIA
HEIGHT	5/10/15MM
WEIGHT	2.3/4.3/7.3G

PEDALS

	LYNX
SIZE	100x104mm
MATERIAL	AL6061 CNC
BEARING	3 SEALED BEARINGS
AXLE	CR-MO CNC
WEIGHT	388G/PR



TT ELEMENTS





Triangle section for better control

NEW
TIME ZONE AEROBAR
TTH-17

MATERIAL: UD CARBON
WIDTH: 400MM
LENGTH: MAX. 300MM(C TO TOP) , MIN. 240MM
EXTENSION BAR: S BAR, UP / DOWN ANGLE: 20°
EXTENSION BAR: S BAR, R / L ANGLE: 10°
ARMRESTS R / L ADJUSTABLE : R/30MM, L/30MM
ARMRESTS F / B ADJUSTABLE : F/50MM, B/50MM
ARMREST'S +/- ADJUSTABLE ANGLE: 10°(+/-5°)
OPTION SPACERS: SPACERS 20MM OR 40MM OR 60MM
WEIGHT: 650G (MIN STACK)(TBD)
COLOR: RED/GRAY

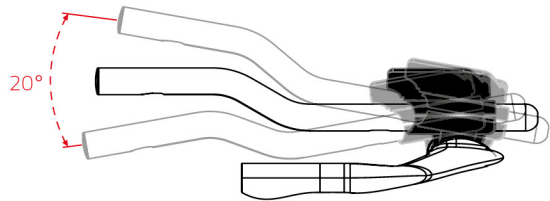
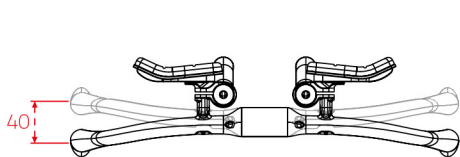
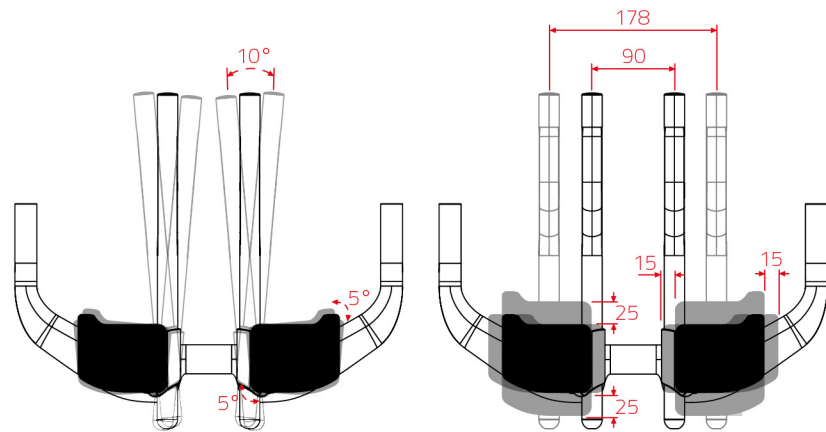

SMART BAR GRIP

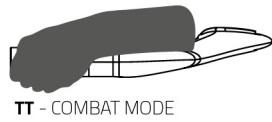

TT - COMBAT MODE

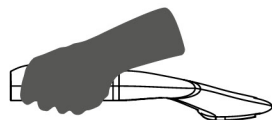

TRIATHLON - ENDURANCE MODE



NEW
THS-01
TIME ZONE HYDRATION SYSTEM

MATERIAL: HDPE+PA66-GF30
CAPACITY: 800ML(TBD)
SIZE: L 262x W 71x H 191MM
WEIGHT: 396G(TBD)



CONTROL
TTH-17



**AERO COCKPIT CARBON
TTH-09CB**

MATERIAL: CARBON
CLIP-ON HANDLEBAR
CLAMPØ: 31.8MM
20MM FRONT ADJUSTMENT
WEIGHT: 309G
COLOR: RED/GRAY



**AERO COCKPIT AL
TTH-09AL**

MATERIAL: ALLOY+CARBON
CLIP-ON HANDLEBAR
CLAMPØ: 31.8MM
20MM FRONT ADJUSTMENT
WEIGHT: 339G
COLOR: RED/GRAY



**AERO COCKPIT PADS
TTH-09P**



**AERO COCKPIT PLUS
TTH-12**

MATERIAL: CARBON
CLIP-ON HANDLEBAR
CLAMPØ: 31.8MM
34MM FORWARD OR 34MM BACKWARD
ADJUSTMENT
WEIGHT: 259G
COLOR: RED/GRAY



**AERO COCKPIT PLUS PADS
TTH-12P**



**AERO TT AL
TTH-11**

MATERIAL: ALLOY + CARBON
20MM FRONT ADJUSTABILITY
EASY TO ASSEMBLE AND REMOVE
WEIGHT: 485G
COLOR: RED/GRAY



**AERO TT AL PADS
TTH-11P**



**IMPEL TT
TTH-13**

MATERIAL: CARBON
LENGTH: 168MM
CLAMPØ: 31.8MM
WEIGHT: 280G
COLOR: RED/GRAY



**IMPEL PAD
TTH-13P**



**FALCON CLIP-ON BAR (U BEND)
TTH-14**

MATERIAL: AL6061
 LENGTH: MAX. 190MM, MIN. 160MM
 ARMREST'S + / - ADJUSTABLE ANGLE: 15°(+/-7.5°)
 ARMREST'S R / L ADJUSTABLE : R/30MM, L/30MM
 CLAMPØ: 31.8MM
 WEIGHT: 407G (WITH PAD)
 COLOR: RED/GRAY



**FALCON TT BAR(S BEND)
TTH-15**

MATERIAL: AL6061
 LENGTH: MAX. 303MM(CLAMP CENTER TO TOP)
 MIN. 253MM
 EXTENSION BAR: S BAR, RISE 29MM
 ARMREST'S R / L ADJUSTABLE : R/30MM, L/30MM
 ARMREST'S + / - ADJUSTABLE ANGLE: 15°(+/-7.5°)
 OPTION SPACERS: 20MM OR 40MM OR 60MM
 WEIGHT: 450G (WITH PAD)
 COLOR: RED/GRAY



**FALCON TT BAR(J BEND)
TTH-16**

MATERIAL: AL6061
 LENGTH: MAX. 303MM(C TO TOP), MIN. 253MM
 EXTENSION BAR: J BAR, UP(C TO C) 55MM
 ARMREST'S R / L ADJUSTABLE : R/30MM, L/30MM
 ARMREST'S + / - ADJUSTABLE ANGLE: 15°(+/-7.5°)
 OPTION SPACERS: 20MM OR 40MM OR 60MM
 WEIGHT: 462G (WITH PAD)
 COLOR: RED/GRAY



**PAD
TTH-15P**



**FALCON REAR HYDRATION SYSTEMS
BC-31**

MATERIAL: AL6061 + PLASTIC
 WEIGHT: 202G
 MULTIFUNCTION ADJUSTMENTS
 (ANGLE UP TO 45° / HEIGHT UP TO 30MM)
 DOUBLE OR SINGLE WATER BOTTLE RACK AVAILABLE
 COLOR: RED/GRAY



**BULL HORN CARBON
RA-508-8**

MATERIAL: 3K CARBON
 BARBOREØ: 31.8MM
 WIDTH: 400MM
 CABLE ROUTING:GROOVE
 WEIGHT: 158G
 COLOR: RED/GRAY



**BULL HORN ALLOY
RA-499DB7-8**

MATERIAL: AL7075
 BARBOREØ: 31.8MM
 WIDTH: 400MM
 CABLE ROUTING:GROOVE
 WEIGHT: 260G
 COLOR: RED/GRAY



**NEW
TRI-POWER UNIT
BAG-01**

MATERIAL: TPR+ABS
 CAPACITY: 260CM³
 SIZE: 220x42MM
 WEIGHT: 155G(TBD)



**TT LEVER
TTL-01**

MATERIAL: 3K CARBON
 INNERØ: 20MM
 WEIGHT: 124G/PAIR



**AERO SUPPLY
BC-27**

MATERIAL: CARBON
 WEIGHT: 197G
 SUPER STRONG &
 LIGHTWEIGHT
 COMPATIBLE HOLES
 FOR CO2 CARTRIDGE
 COLOR: RED/GRAY

TT COLLECTION SPEC

TT BAR

	TIME ZONE AERO	AERO COCKPIT CARBON	AERO COCKPIT ALLOY	AERO TT AL	AERO COCKPIT PLUS	IMPEL TT	FALCON CLIP-ON U BEND	FALCON TT S BEND	FALCON TT J BEND
BARBOREØ	31.8	31.8	31.8	31.8	31.8	31.8	31.8	31.8	31.8
HANDLE ADJUSTMENT(MM)	-	15	15	15	34	-	-	-	-
PAD HOLDER ADJUSTMENT(MM)	L 30 F50 R 30 B50	-	-	L 30 R 30	34	-	L 30 R 30	L 30 R 30	L 30 R 30
PAD HOLDER ANGLE	L/R 10°(+/- 5°)	-	-	-	-	-	L/R 15°(+/- 7.5°)	L/R 15°(+/- 7.5°)	L/R 15°(+/- 7.5°)
CLAMP ADJUSTMENT(MM)	-	5	5	5	-	-	-	-	-
WING WIDTH(MM)	400	-	-	-	-	-	-	-	-
EXTENSION LENGHT(MM)	MAX 300 MIN 240	-	-	-	-	-	MAX 190 MIN 160	MAX 315 MIN 255	MAX 303 MIN 253
EXTENSION BAR ANGLE	U/D 20° L/R 10°	-	-	-	-	-	-	-	-
EXTENSION BAR UP(C TO C)	30	-	-	-	-	-	-	28	55
OPTION SPACERS(MM)	20/40/60	-	-	-	-	-	20/40/60	20/40/60	20/40/60
FINISH	MATT BLACK SHINY BLACK	MATT BLACK SHINY BLACK	AL-SB BLACK CB: MATT BLACK SHINY BLACK	AL-SB BLACK CB: MATT BLACK SHINY BLACK	MATT BLACK SHINY BLACK	MATT BLACK SHINY BLACK	SB BLACK	SB BLACK	SB BLACK
MATERIAL	UD CARBON	3K CARBON	AL7075+ UD CARBON	AL7075+ UD CARBON	3K CARBON	3K CARBON	AL6061	AL6061	AL6061
BOLTS	STAINLESS STEEL	TITANIUM	STAINLESS STEEL	STAINLESS STEEL	TITANIUM	SCM-435	SCM-435	SCM-435	SCM-435
WEIGHT	650G(TBD)	309G	338G	485G	259G	276G	407G	450G	462G

BASEBAR

	BULL HORN CARBON	BULL HORN ALLOY
BARBORE	31.8	31.8
WIDTH(MM)	400	400
CABLE ROUTING	GROOVES	GROOVES
FINISH	3K CARBON	SB BLACK
MATERIAL	CARBON	AL7075
WEIGHT	158G	260G

TT LEVER

	LEVER
BODY MATERIAL	AL7075
LEVER MATERIAL	3K CARBON
INNER Ø(MM)	20
WEIGHT	124G/PAIR



NON SERIES



AFFILADO SP-1350

MATERIAL: UD CARBON
POSTØ: 27.2/31.6MM
SADDLE DIM: 285x135MM
LENGTH: 300/350MM
WEIGHT: 251G (L300MM, Ø27.2MM)



STOKER ATB-922

MATERIAL: 3D FORGED AL6061
LENGTH: 190-230/215-255MM
ANGLE: +35°
HANDLEBARØ: 25.4/31.8MM
SEATPOSTØ: 29.8/31.6MM
STACK HEIGHT: 51MM
WEIGHT: 352G (190-230MM, Ø29.8/Ø25.4)

ACCESSORIES



SETTLE SC-93

MATERIAL: AL7075
INNERØ: 31.8/34.9MM
WEIGHT: 14G(34.9MM)
HOLLOW DESIGN



CONTROL SEAT CLAMP SC-74QR

MATERIAL: AL2014 COLLAR
INNERØ: 31.8/34.9MM
WEIGHT: 52G
STAINLESS STEEL AXLE
ALUMINUM CLAMP LEVER



ADAPT SC-91

MATERIAL: AL6061
INNERØ: 31.8/34.9MM
WEIGHT: 26G
HOLLOW DESIGN



COMP CAP CAP-28

CARBON STEERER FORK FRIENDLY,
INTERNAL EXPANDING SYSTEM
23.3 - 25.4MM(BETTER THAN STAR
FANGLED NUT)
WITH CABON TOP CAP
WEIGHT: 29G



TERMINATOR PLUGS AC-62

MATERIAL: AL6061
EXTERNAL: 23.8MM
FINISH: BLACK
WEIGHT: 45G/PAIR



CAP ALLOY CAP-29

CARBON STEERER FORK FRIENDLY,
INTERNAL EXPANDING SYSTEM
23.3 - 25.4MM(BETTER THAN STAR
FANGLED NUT)
WEIGHT: 30G



TERMINATOR MTB AC-63

MATERIAL: AL6061
EXTERNAL: 22.2MM
FINISH: BLACK
WEIGHT: 37G/PAIR



DBH(DI2 BATTERY HOLDER) AC-69

MATERIAL: RUBBER
SEATPOSTØ: 27.2/30.9/31.6MM
WEIGHT: 6G(Ø27.2MM)
HOLLOW DESIGN
USE FOR SHIMANO INTERNAL BATTERY
(SM-BTR2) SECURELY HIDE YOUR DI2
BATTERY WITHIN YOUR SEATPOST



**RHS
HS-951**

SIZE: UPPER 1-1/8", LOWER 1-1/2"
FINISH: ANODIZED BLACK
DIAMETERØ: 28.6/41.8-52/39.8MM
STACK HEIGHT: 8.8+0.7=9.5MM
BEARINGS: SEALED CARTRIDGE
WEIGHT: 103G



**MHS
HS-952**

SIZE: UPPER 1-1/8", LOWER 1-1/2"
FINISH: ANODIZED BLACK
DIAMETERØ: 28.6/44-56/39.8MM
STACK HEIGHT: 7.3+3=10.3MM
BEARINGS: SEALED CARTRIDGE
WEIGHT: 163G



**BURST
PD-03**

MATERIAL: EXTRUDED / ALUMINUM
SIZE: 107x100x26MM PLATFORM
BEARINGS: DU/SEALED
REPLACEABLE PINS
WEIGHT: 379G/PER PAIR



**TESTY
GP-12**

LENGTH: 128MM
WEIGHT: 93G/PAIR
LOCK ON GRIP SYSTEM
NARROW PROFILE WITH FLANGE
BLACK ALLOY



**SILICONE MTB GRIPS
GP-16**

MATERIAL: 100% SILICONE
LENGTH: 130MM
WEIGHT: 75G/PAIR
UV RESISTANT, RE-WRAPABLE, SHOCK
ABSORBING
COMFORTABLE, EASY TO INSTALL,
SUPER TACKY



**NEW
CARBON BOTTLE CAGE
BC-37**

MATERIAL: UD CARBON
WEIGHT: 22G
COLOR: RED/GRAY



**FALCON BOTTLE CAGE
BC-33**

MATERIAL: PLASTIC BOTTLE CAGE
(MATTE BLACK STANDARD)
WEIGHT: 30G
COLOR: RED / GRAY



**MTB GRIP COLOR
GP-17**

MATERIAL: PP+TPR+ALLOY
SIZE: 22.4x130MM
WEIGHT: 105G



**MTB GRIP COLOR
GP-18**

MATERIAL: PP+TPR+ALLOY
SIZE: 22.4x130MM
WEIGHT: 105G



**CONTROL QUICK RELEASE
QR-25**

LENGTH: 100-130,100-135
FINISH: BLACK
WEIGHT: 70G
ALLOY TITANIUM



**COMP QR
QR-27**

LENGTH: 100-130,100-135
FINISH: BLACK
WEIGHT: 63G
CARBON TITANIUM



**RACE LIGHT SKEWERS
BT-06**

LENGTH: 100-130,100-135
FINISH: BLACK
WEIGHT: 26G
SPAN KEY
TITANIUM
ANTI-THEFT



**CARBON SPACERS
HSS-13**

FIBER FOR 28.6MM HEADSET
HEIGHT: 5/10/15/20/25MM
WEIGHT: 1.4G(5MM),2.8G(10MM)



**BAR TAPE
HT-07**

MATERIAL: EVA
SIZE: 3CM x 185CM
WEIGHT: 48G/PAIR
HIGH PERFORMANCE HANDLEBAR RIBBON
EVA FOAM MATERIAL REDUCES FATIGUE



**SILICONE BAR TAPE
HT-08**

MATERIAL: 100% SILICONE
COMFORTABLE, EASY TO INSTALL, SUPER TACKY
SIZE: 3CM X 165CM
WEIGHT: 118G/PAIR

TECHNOLOGY

CT T-SHIRT 6C-CTRR

MATERIAL: 100% COTTON
SIZE: S/M/L/XL
COLOR: RED



CT T-SHIRT 6C-CTRB

MATERIAL: 100% COTTON
SIZE: S/M/L/XL
COLOR: BLACK



It's easy to make a simple product look simple – but it takes genius to make a complex one elegant. That's where Controltech excels. Components such as handlebars, seatposts and even wheels may look simple, but if you want high performance, you inevitably introduce a great deal of complexity under the skin and behind the scenes.

At Controltech, we break that down to four key elements. First, there's the ideas stage, but even our Research & Development is inextricably linked with a hard understanding of materials and manufacturing. Our innovation and engineering overlaps real-world riding with pure science and good engineering – it's the only way to work out not just what's possible, but what's desirable.

Next, we look at aerodynamics, using a mix of

Computational Fluid Dynamics (CFD) and real-world performance testing. It's a vital area for road and especially triathlon products, and our longstanding expertise in carbon fiber and high-precision alloy milling mean Controltech's use of shaping is second to none.

We never restrict ourselves to one material, even within a single component. Each part of every piece is carefully specified for its particular properties: the strength of steel, the low density of aluminum, the exotic hardness of titanium, or just about any aspect of the many different types of carbon our experts work with. With Controltech's hard-won knowledge, carbon can be optimized in any number of areas, styles and

directions at once.

Last – and least, in one very specific sense – is weight. Low weight is vital, yet when you put this much effort into the first three areas, it almost takes care of itself. Careful design, the correct choice and sourcing of materials and beautifully minimalistic shaping combine with advanced manufacturing techniques – such as multiple tube wall thicknesses, intense CNC machining and complex one-piece moulding – to create very low weights without structural compromise. Controltech builds strong, it builds light, and it builds advanced.



CONTROLTECH WORLDWILD DISTRIBUTORS

Area	Country	Distributor Company Name	Address	Tel. No.	Web
Asia	China	BH-BIKES CHINA	No. 155 Baiyundu Rd., Ludu Town, Taicang City, Jiangsu, China	+86-512-5328-9080	www.bhbikeschina.com
Asia	Hong Kong	Kung Sheung Cycle Co.	39D Battery Street, Jordan, Kln., H.K	+852-2385-2080	www.kungsheungcycle-part.com.hk
Asia	Taiwan	Dalux Int. Co. Ltd	No. 12, Ln. 538, Sec. 1 Yuandong Road, Yuanlin City, Changhua, Taiwan	+886-4-8353575	www.krex.com.tw
Asia	Singapore	SKYE VENTURES PTE LTD	67 Frankel Ave Singapore 458194	+65-6810-2898	www.skye-ventures.com
Asia	Thailand	AMORN ELECTRONIC CENTER SPARE PART CO., LTD.	17/18-19 Moo 6, Bangkratuak, Amphur Sampran Nakornprathom 73210, Thailand	+66-2-4821320	www.amornbicycle.com
Asia	Indonesia	Bagus bike	Komp. Ruko sektor 7 blok rn 61 tangerang 15310, Indonesia	+62-21-5371115	www.bagusbike.com
Asia	Philippines	Bike One Cycle Mart	Unit 9 Pasda Bldg, Araneta Ave. Cor P. Florentino st Brgy. Sto Domingo Quezon City, Philippines	+63-2516-3553	www.bikeonecycle.com
Asia	Japan	Dragon Bike			www.dragonbike.net
America	Brazil	Soul Cycles	Rodovia Jorge Lacerda, 1010 - Galpão 3, Bairro Espinheiros - Itajaí - SC - Brasil CEP 88317-100	+47 3404-4100	www.soulcycles.com.br
America	Chile	MKR IMPORTS	San Diego #1184 Santiago - Chile	+56 22 555 5743	www.mkr.cl
Europe	Germany	Zoulou-Bikes GmbH & Co. KG	Roermonder Strabe 590, 52072 Aachen, Germany	+49(0)241-95598822	www.zoulou-bikes.com
Europe	Germany	Diegelmann & Jacobi GmbH	In den Nassen 4 DE - 65719 Hofheim/Ts. Germany	+49(0)6192-9293-60	www.diegelmannshop.de
Europe	Germany	JBS GmbH & Co. KG	Ernst-Abbe-Str. 28 DE - 52249 Eschweiler Germany	+49(0)2403-7836-10	www.droessiger.de
Europe	Portugal	ELICA – Electromecânica, Lda	Avenida General Roçadas, 93-B, 1170-156 Lisboa, Portugal	+351-21816-0290	www.cycletech.pt
Europe	Switzerland	UGD Sport diffusion SA	La Taille CH 2053 Cernier, Switzerland	+41-0-328536363	www.ugd.ch
Europe	Poland	Merida Polska SP. Z O.O.	UL.M.C. Skłodowskiej 35. 41-800 Zabrze, Poland	+48-32-273-3232	www.rowerymerida.pl

DISTRIBUTORS

